

# VIKING PRODUCT MANUAL

COMMUNICATION &amp; SECURITY SOLUTIONS

## Add Paging and Multiple Line Loud Ringing to Any Phone System

The **PA-2A** provides loud ringing and paging to electronic key systems, 1A2 Key systems, PABX's as well as No-KSU phones and multiline phones.

Paging is accomplished by connecting the **PA-2A** to a paging port or unused telephone line input (trunk port) of nearly any phone system.

The **PA-2A** will also generate adjustable loud ringing from up to 6 analog lines or from a dry contact closure. Either a loud electronic warble, or one of three other soft chime sounds may be selected. An external "night transfer" switch can be added to turn loud ringing on or off in night bell applications.

The **PA-2A** is easy to install and eliminates the installation of multiple bells, relays and paging cards.



The unit comes complete with a power supply, amplifier and (1) Viking 25AE paging horn.

### Features

- Two watts of paging power
- Includes (1) Viking **25AE** paging horn
- All lines are optically coupled for compatibility with fax switches and analog PABX/KSU stations
- Can provide background music from an external source (trunk mode only)
- Paging from an unused trunk port or paging port
- Choose one of four ringing sounds:
  - Electronic warble (traditional loud ringer)
  - Double gong (two identical "gong" tones)
  - Quadruple chime (four descending chime tones)
  - Door chime (ding-dong)
- Provides loud ringing or night bell, from 1-6 lines for warehouses, yards, etc.
- Output for controlling a 12 volt relay from 1-6 ringing lines
- Page alert tone (trunk mode only)
- 600 ohm output for sourcing high powered amplifiers

### Applications

- Amplified loud paging
- Night bell
- Loud ringing

[www.vikingelectronics.com](http://www.vikingelectronics.com)  
Information: (715) 386-8861

### Specifications

**Power:** 120V AC/13.8V AC 1.25A, UL listed adapter provided

**Dimensions:** 133mm x 89mm x 44mm (5.25" x 3.5" x 1.75")

**Shipping Weight:** 1.36 kg (3 lbs)

**Environmental:** 0°C to 32°C (32°F to 90°F) with 5% to 95% noncondensing humidity

**Paging Output:** 2 watts - powers up to (3) 8 ohm or (16) 45 ohm speakers

**Sound Pressure:** 108 dB, 1 kHz @ 1 meter with (1) **25AE** paging horn (included). See Page Power Chart for more info, **DOD# 895**.

**Speakers:** (1) **25AE** 8 ohm paging horn included, (3) maximum

**Maximum Speaker Run:** See Speakers section, page 6

**Talk Battery:** 24V DC

**Connections:** (2) RJ25 jacks, (1) 10 position screw terminal block

# Features Overview

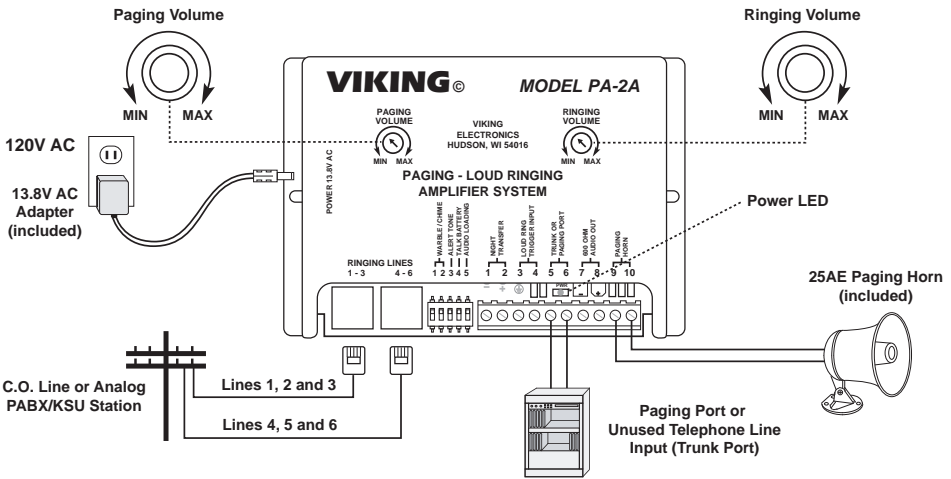

# Installation

## A. Amplified Loud Paging

### 1. Paging Port

<b>Step 1</b>	Move the <b>TALK BATTERY</b> DIP switch to the <b>OFF</b> position ( <b>DIP switch 4</b> ).
<b>Step 2</b>	Connect pins <b>5</b> and <b>6</b> to the paging port output.

*Note:* For information on speakers to use, ambient noise levels, and speaker wiring, see **DOD# 498 and 895**.

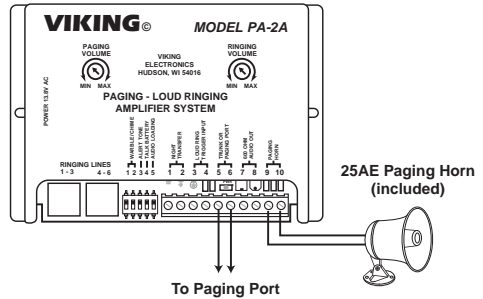

### 2. Trunk/Line Port

<b>Step 1</b>	Move the <b>TALK BATTERY</b> DIP switch to the <b>ON</b> position ( <b>DIP switch 4</b> ).
<b>Step 2</b>	Move the <b>AUDIO LOADING</b> switch to the <b>OFF</b> position ( <b>DIP switch 5</b> ).
<b>Step 3</b>	Connect pins <b>5</b> and <b>6</b> to an unused telephone line input (trunk port).
<b>Step 4</b>	Background music may be added as shown, the music level will be greatly reduced during page.

*Note:* For information on speakers to use, ambient noise levels, and speaker wiring, see **DOD# 498 and 895**.

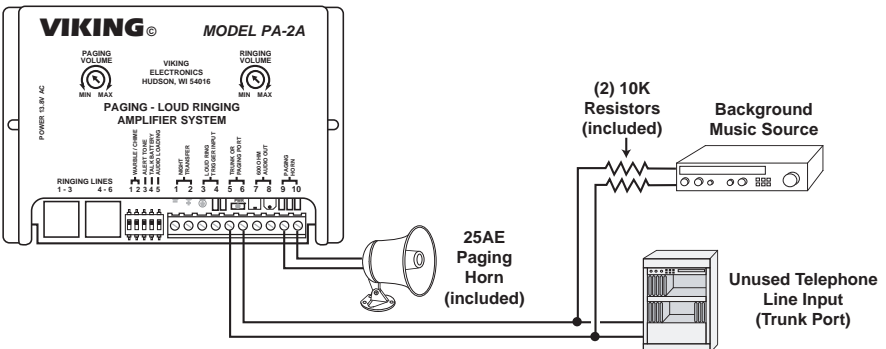

## B. Loud Ringing / Night Bell

### 1. Ringing Analog Lines

<b>Step 1</b>	Connect lines 1 (R/G), 2 (Y/BK) and 3 (BL/W) to <b>RINGING LINES 1-3</b> .
<b>Step 2</b>	Connect lines 4 (R/G), 5 (Y/BK) and 6 (BL/W) to <b>RINGING LINES 4-6</b> .

*Note: For information on speakers to use, ambient noise levels, and speaker wiring, see **DOD# 498** and **895**.*

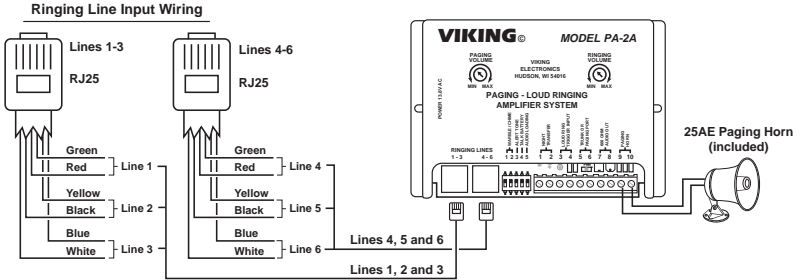

### 2. Dry Contact (Common Audible) Closure (contacts not included)

<b>Step 1</b>	Connect the dry contact closure to pins 3 and 4.
<b>Step 2</b>	A dry contact closure will initiate loud ringing.

*Note: For information on speakers to use, ambient noise levels, and speaker wiring, see **DOD# 498** and **895**.*

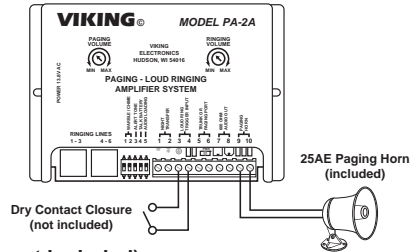

### 3. Night Transfer (Loud Ringing) Switch (switch not included)

A Night Transfer Switch may be used to enable or disable loud ringing.

#### a. Ringing Analog Lines

Connect the night transfer switch to terminal pins 1 and 2. When the switch is on (closed), loud ringing is disabled. When the switch is off (open), loud ringing is enabled.

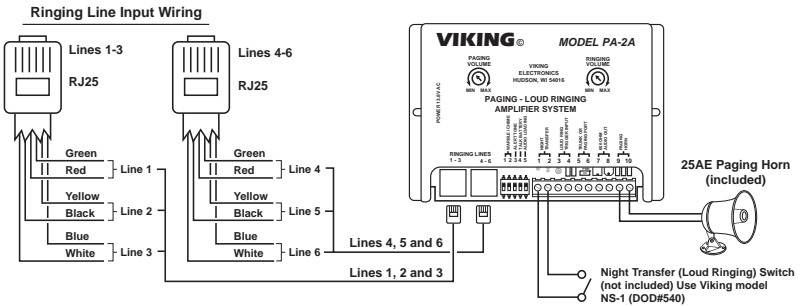

*Note: For information on speakers to use, ambient noise levels, and speaker wiring, see **DOD# 498** and **895**.*

#### b. Dry Contact Closure with Night Transfer (Loud Ringing) Switch

Interface the night transfer switch in series with the contact closure. When the switch is on (closed), loud ringing is enabled. When the switch is off (open), loud ringing is disabled.

*Note: For information on speakers to use, ambient noise levels, and speaker wiring, see **DOD# 498** and **895**.*

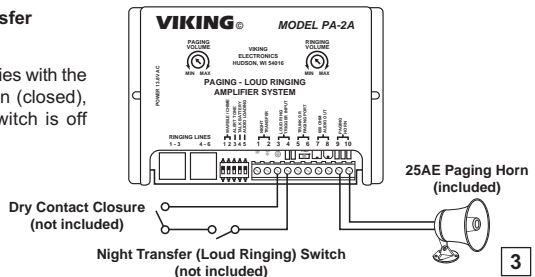

### C. Contact Closure From Up to 6 Ringing Lines

When a 12V DC relay coil (Radio Shack part: # 275-042, not included) is connected as shown in the diagram below, the relay is activated for the duration of each ring on 1-6 C.O. lines or analog PABX/KSU stations.

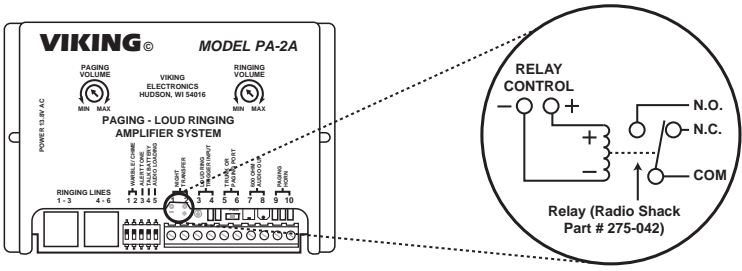

### D. Long Runs Between Amplifier and Speakers

Very long runs between the PA-2A and the speakers might require 70V transformers (Parts Express 1-800-338-0531, part # 300-040 or equivalent).

**Note:** For additional information on how to minimize loss of audio in long speaker runs, see DOD# 856.

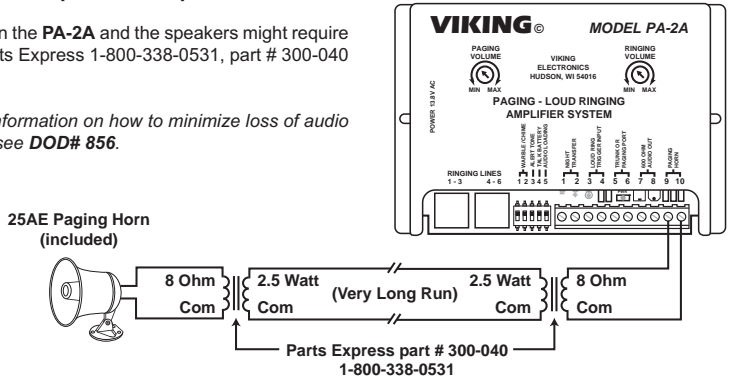

### E. Connecting Multiple PA-2A's

When more than 6 ringing lines are to be monitored or additional amplifiers need to be added, install as shown below, using the 600 OHM AUDIO OUTPUT connections.

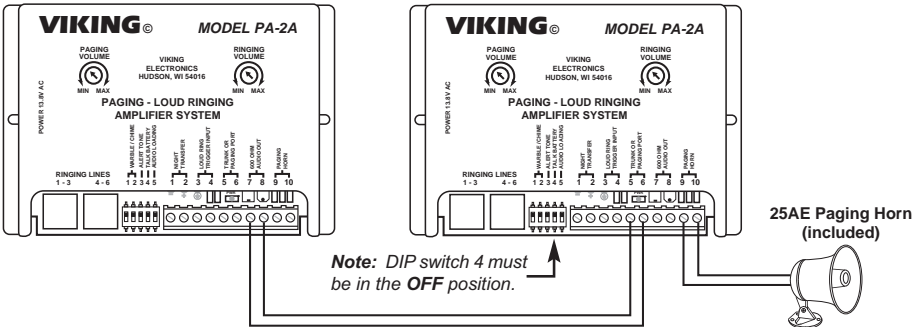

## F. Adding Additional Paging Power

An external amplifier can be added to increase the paging and loud ringing power. Simply connect the **600 OHM AUDIO OUTPUT** screw terminals to the line level input of any high powered paging amplifier, such as the 30 Watt Viking PA-30, the 60 Watt Viking PA-60 (not shown), or any existing paging system.

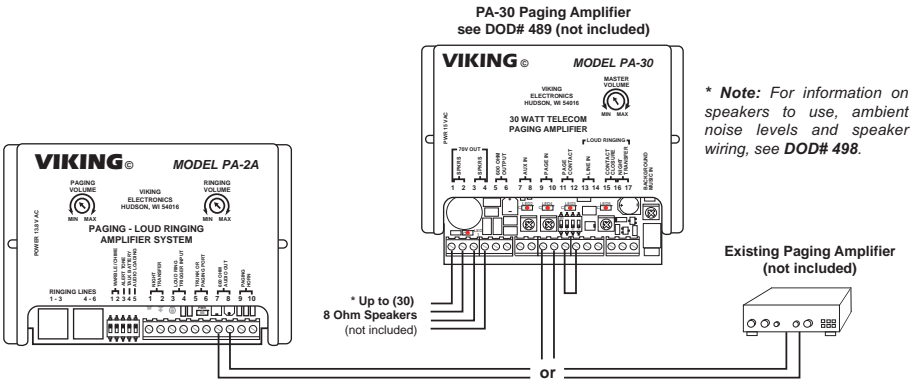

## G. Add Paging to Homes and Small Businesses with Single Line Phones

The **C-1000B** can be added to allow **PA-2A** paging from the existing single line phones. If need be, a doorbox or a second paging amplifier may also be added to the **C-1000B** Doorbox 2 Terminals. For more information on the **C-1000B**, see DOD# 168.

<b>Step 1</b>	Program the <b>C-1000B</b> to be in the Paging Mode *4.
<b>Step 2</b>	Set the <b>C-1000B</b> Talk Battery switch <b>OFF</b> .
<b>Step 3</b>	Connect the <b>PA-2A</b> Trunk Port (pins 5 & 6) to the <b>C-1000B</b> Door Box 1 terminals.
<b>Step 4</b>	Move the <b>PA-2A</b> Talk Battery switch <b>ON</b> (DIP switch 4).
<b>Step 5</b>	To page, come off hook on the phone and dial #1.

### C-1000B Door Entry/Paging Controller (not included)

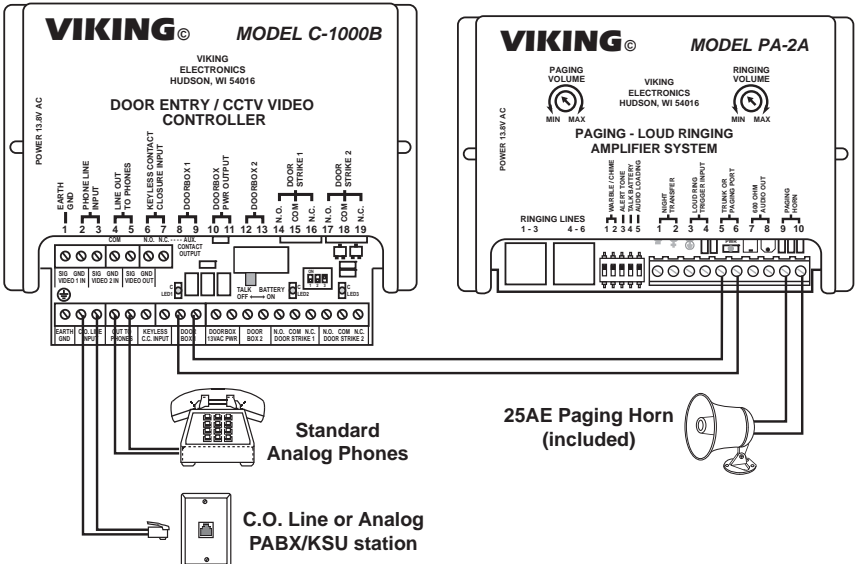

# Programming

## DIP Switch Programming

Switch 1	Switch 2	Sound Output Description
OFF	OFF	Electronic Warble (Loudest Sound)
OFF	ON	Double Gong (Soft & Pleasant)
ON	OFF	Quadruple Chime (Soft & Pleasant)
ON	ON	Door Chime (Soft & Pleasant)

Switch	Position	Description
3	OFF	Alert tone OFF (factory default)
3	ON	Alert tone ON
4	OFF	Talk battery OFF (factory default)
4	ON	Talk battery ON
5	OFF	Audio load 10K (for applications using background music)
5	ON	Audio load 600 ohms (factory default)

**Note:** DIP Switches are shown in factory default positions.

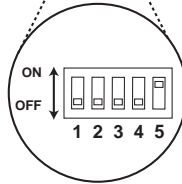
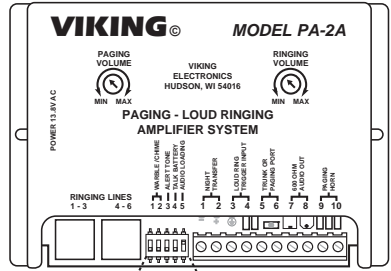

# Speakers

## A. Speakers

The **PA-2A** contains an amplifier which can drive up to three 8-ohm speakers. The more speakers that are used, the less shared power each speaker will receive, the softer they will each play. A single speaker with a short speaker wire run will receive the full 2 watts of power, where if 3 speakers are used, there will be less than 1 watt of power available for each speaker. See **DOD# 895** for additional information on paging horn volume per number of speakers being used. If additional paging power is needed, add a Viking model **PA-60** for 60 more watts of paging power.

Another consideration when budgeting speakers is paging power that is lost in the wire runs. A single speaker on a short heavy gauge wire will have no loss, but many speakers on a long light gauge wire will have an unacceptable amount of volume lost. Use the below chart as a guide line to keep the volume lost limited to less than 5db. Using half the recommended distance or half as many speakers per run will keep the volume lost limited to less than 3db.

## B. Managing Power Losses

Maximum recommended length (in feet) for the number of 8 Ohm speakers on a wire pair to maintain a volume loss of less than 5db.

**Note 1:** Mount the amplifier close to where the speakers are installed to minimize the speaker wire run lengths.

**Note 2:** Using half the recommended distance or half as many speakers per run will keep the volume lost limited to 3db.

**Note 3:** Doubling up the wires will allow double the length, or reduce the amount of volume loss.

**Note 4:** Heavier gauge wire, fewer speakers per run, and shorter runs will all minimize volume loss.

Wire Gauge Size

#16	2,000'	1,000'	665'
#18	1,250'	625'	420'
#20	800'	400'	265'
#22	500'	250'	165'
#24	315'	155'	105'
	1	2	3

**Number of 8 Ohm Speakers on a Wire Run**

## Sound Output Specifications

All tones require a minimum of 180ms of ringing voltage (or contact closure) to trigger. Once triggered, the electronic warble will run continuously until ringing stops (or contacts open). All other tones (double gong, quadruple chime, doorbell) will run through their full sequence once and will not cycle again until the ringing stops (or contact opens) for at least 50ms and a second ring signal (or contact closure) triggers them again.

### A. Electronic Warble (Traditional Loud Ringer)

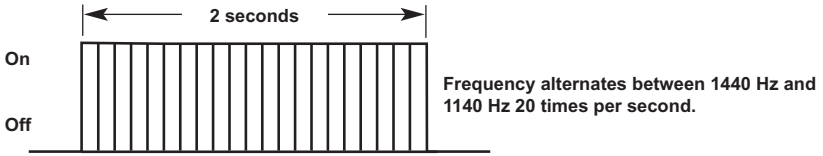

### B. Double Gong (Two "Gong" Tones)

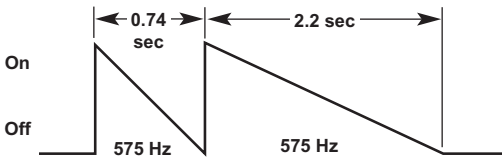

### C. Quadruple Chime (Four Descending Chime Tones)

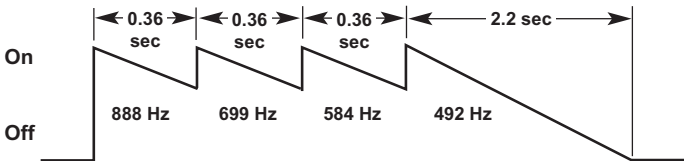

### D. Door Chime (Ding-Dong)

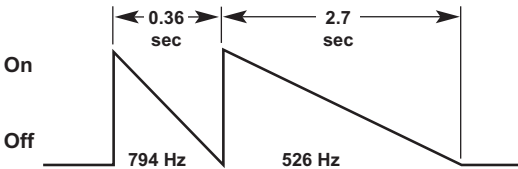

## Operation

When interfacing the **PA-2A** to a paging port, the **TALK BATTERY** switch (DIP switch 4) must be **OFF**. The **PA-2A** will amplify all signals sent from the paging port. The page alert tone (DIP switch 3) is not an available option.

When interfacing with an unused telephone line input (trunk port), the **TALK BATTERY** switch (DIP switch 4) must be **ON** and the **PA-2A** must be connected to an unused trunk port. Simply access that trunk port and talk into the handset to page. A page alert tone may be enabled or disabled with DIP switch 3. When the page alert tone is enabled, paging will interrupt and hold off loud ringing for the duration of the page.

In both instances, the **PA-2A** can monitor 1 - 6 C.O. lines, 1 - 6 analog PABX/KSU stations or a dry contact closure for loud ringing. The **PA-2A** will produce the selected ringing tone when ring voltage is detected on these line inputs or a contact is closed on pins 3 and 4. Select the electronic warble tone (traditional loud ringing) for noisy areas. The softer chime tones work well in less noisy environments.

# Warranty

IF YOU HAVE A PROBLEM WITH A VIKING PRODUCT, CONTACT: VIKING TECHNICAL SUPPORT AT (715) 386-8666

Our Technical Support Department is available for assistance Monday 8am - 4pm and Tuesday through Friday 8am - 5pm central time. So that we can give you better service, before you call please:

1. Know the model number, the serial number and what software version you have (see serial label).
2. Have your Technical Practice in front of you.
3. It is best if you are on site.

## RETURNING PRODUCT FOR REPAIR

The following procedure is for equipment that needs repair:

1. Customer must contact Viking's Technical Support Department at 715-386-8666 to obtain a Return Authorization (RA) number. The customer MUST have a complete description of the problem, with all pertinent information regarding the defect, such as options set, conditions, symptoms, methods to duplicate problem, frequency of failure, etc.
2. Packing: Return equipment in original box or in proper packing so that damage will not occur while in transit. Static sensitive equipment such as a circuit board should be in an anti-static bag, sandwiched between foam and individually boxed. All equipment should be wrapped to avoid packing material lodging in or sticking to the equipment. Include ALL parts of the equipment. C.O.D. or freight collect shipments cannot be accepted. Ship cartons prepaid to: **Viking Electronics, 1531 Industrial Street, Hudson, WI 54016**
3. Return shipping address: Be sure to include your return shipping address inside the box. We cannot ship to a PO Box.
4. RA number on carton: In large printing, write the R.A. number on the outside of each carton being returned.

## RETURNING PRODUCT FOR EXCHANGE

The following procedure is for equipment that has failed out-of-box (within 10 days of purchase):

1. Customer must contact Viking's Technical Support at 715-386-8666 to determine possible causes for the problem. The customer MUST be able to step through recommended tests for diagnosis.
2. If the Technical Support Product Specialist determines that the equipment is defective based on the customer's input and troubleshooting, a Return Authorization (R.A.) number will be issued. This number is valid for fourteen (14) calendar days from the date of issue.
3. After obtaining the R.A. number, return the approved equipment to your distributor, referencing the R.A. number. Your distributor will then replace the Viking product using the same R.A. number.
4. The distributor will NOT exchange this product without first obtaining the R.A. number from you. If you haven't followed the steps listed in 1, 2 and 3, be aware that you will have to pay a restocking charge.

## TWO YEAR LIMITED WARRANTY

Viking warrants its products to be free from defects in the workmanship or materials, under normal use and service, for a period of two years from the date of purchase from any authorized Viking distributor. If at any time during the warranty period, the product is deemed defective or malfunctions, return the product to Viking Electronics, Inc., 1531 Industrial Street, Hudson, WI., 54016. Customer must contact Viking's Technical Support Department at 715-386-8666 to obtain a Return Authorization (R.A.) number.

This warranty does not cover any damage to the product due to lightning, over voltage, under voltage, accident, misuse, abuse, negligence or any damage caused by use of the product by the purchaser or others. This warranty does not cover non-EWP products that have been exposed to wet or corrosive environments. This warranty does not cover stainless steel surfaces that have not been properly maintained.

**NO OTHER WARRANTIES.** VIKING MAKES NO WARRANTIES RELATING TO ITS PRODUCTS OTHER THAN AS DESCRIBED ABOVE AND DISCLAIMS ANY EXPRESS OR IMPLIED WARRANTIES OR MERCHANTABILITY OR FITNESS FOR ANY PARTICULAR PURPOSE.

**EXCLUSION OF CONSEQUENTIAL DAMAGES.** VIKING SHALL NOT, UNDER ANY CIRCUMSTANCES, BE LIABLE TO PURCHASER, OR ANY OTHER PARTY, FOR CONSEQUENTIAL, INCIDENTAL, SPECIAL OR EXEMPLARY DAMAGES ARISING OUT OF OR RELATED TO THE SALE OR USE OF THE PRODUCT SOLD HEREUNDER.

**EXCLUSIVE REMEDY AND LIMITATION OF LIABILITY.** WHETHER IN AN ACTION BASED ON CONTRACT, TORT (INCLUDING NEGLIGENCE OR STRICT LIABILITY) OR ANY OTHER LEGAL THEORY, ANY LIABILITY OF VIKING SHALL BE LIMITED TO REPAIR OR REPLACEMENT OF THE PRODUCT, OR AT VIKING'S OPTION, REFUND OF THE PURCHASE PRICE AS THE EXCLUSIVE REMEDY AND ANY LIABILITY OF VIKING SHALL BE SO LIMITED.

IT IS EXPRESSLY UNDERSTOOD AND AGREED THAT EACH AND EVERY PROVISION OF THIS AGREEMENT WHICH PROVIDES FOR DISCLAIMER OF WARRANTIES, EXCLUSION OF CONSEQUENTIAL DAMAGES, AND EXCLUSIVE REMEDY AND LIMITATION OF LIABILITY, ARE SEVERABLE FROM ANY OTHER PROVISION AND EACH PROVISION IS A SEPARABLE AND INDEPENDENT ELEMENT OF RISK ALLOCATION AND IS INTENDED TO BE ENFORCED AS SUCH.

### FCC REQUIREMENTS

This equipment complies with Part 68 of the FCC rules and the requirements adopted by the ACTA. On the side of this equipment is a label that contains, among other information, a product identifier in the format US:AAAEQ##TXXXX. If requested, this number must be provided to the telephone company.

The REN is used to determine the number of devices that may be connected to a telephone line. Excessive REN's on a telephone line may result in the devices not ringing in response to an incoming call. In most but not all areas, the sum of the REN's should not exceed five (5.0). To be certain of the number of devices that may be connected to a line, as determined by the local REN's, contact the local telephone company. For products approved after July 23, 2001, the REN for this product is part of the product identifier that has the format US:AAAEQ##TXXXX. The digits represented by ## are the REN without a decimal point (e.g., 03 is a REN of 0.3). For earlier products, the REN is separately shown on the label.

The plug used to connect this equipment to the premises wiring and telephone network must comply with the applicable FCC Part 68 rules and requirements adopted by the ACTA. If your home has specially wired alarm equipment connected to the telephone line, ensure the installation of this PA-2A does not disable your alarm equipment. If you have questions about what will disable alarm equipment, consult your telephone company or a qualified installer.

If the PA-2A causes harm to the telephone network, the telephone company will notify you in advance that temporary discontinuance of service may be required. But if advance notice isn't practical, the telephone company will notify the customer as soon as possible. Also, you will be advised of your right to file a complaint with the FCC if you believe it is necessary.

The telephone company may make changes in its facilities, equipment, operations, or procedures that could affect the operation of the equipment. If this happens, the telephone company will provide advance notice in order for you to make the necessary modifications to maintain uninterrupted service.

If trouble is experienced with the PA-2A, for repair or warranty information, please contact:

**Viking Electronics, Inc., 1531 Industrial Street, Hudson, WI 54016 (715) 386-8666**

If the equipment is causing harm to the telephone network, the telephone company may request that you disconnect the equipment until the problem is resolved.

Connection to Party Line Service is subject to State Tariffs. Contact the state public utility commission, public service commission or corporation commission for information.

**WHEN PROGRAMMING EMERGENCY NUMBERS AND (OR) MAKING TEST CALLS TO EMERGENCY NUMBERS:**

Remain on the line and briefly explain to the dispatcher the reason for the call. Perform such activities in the off-peak hours, such as early morning or late evenings.

It is recommended that the customer install an AC surge arrester in the AC outlet to which this device is connected. This is to avoid damaging the equipment caused by local lightning strikes and other electrical surges.

### PART 15 LIMITATIONS

This equipment has been tested and found to comply with the limits for a Class A digital device, pursuant to Part 15 of the FCC rules. These limits are designed to provide reasonable protection against harmful interference when the equipment is operated in a commercial environment. This equipment generates, uses, and can radiate radio frequency energy and, if not installed and used in accordance with the instruction manual, may cause harmful interference to radio communications. Operation of this equipment in a residential area is likely to cause harmful interference in which case the user will be required to correct the interference at his own expense.

**Product Support: (715) 386-8666**

Due to the dynamic nature of the product design, the information contained in this document is subject to change without notice. Viking Electronics, and its affiliates and/or subsidiaries assume no responsibility for errors and omissions contained in this information. Revisions of this document or new editions of it may be issued to incorporate such changes.